

# Laminated Dock Bumpers

## B4506-87-A

4 1/2" X 6" X 87"

### Features

Tough plies of truck tire material virtually eliminates chipping or abrasion, unlike molded rubber, extruded rubber, conveyor belting or wood plank bumpers. Attractive deep black color enhances a neat, professional architectural look. Manufactured under pressure exceeding 1,500 lbs. to absorb over 80% of impact force. Anchor bolts are protected by at least 3" of rubber to prevent damage.

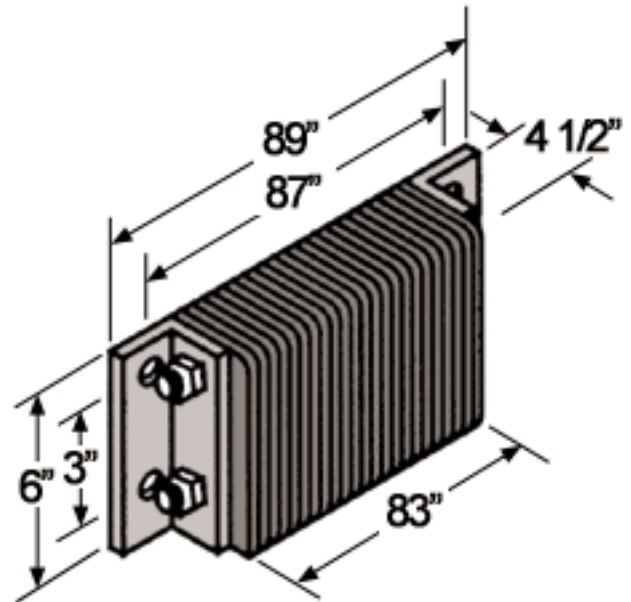

### Material/Thickness

Fabric reinforced rubber pads cut from selected recycled truck tires. Rubber pads laminated between structural steel angles and secured with 3/4" steel tie rods.

### Installation

Structural mounting angles permit welded installations or provide bolting through steel

**Extra Length bumpers must be supported in the center. You will need to specify one of these anchorage devices when placing your order.**

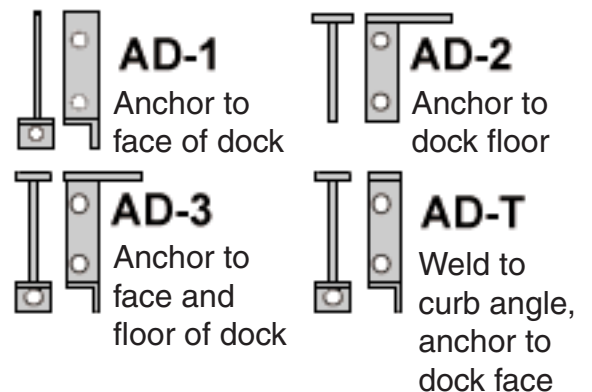

Bumpers may be ordered with angles or flat plates at each end. Use a flat plate for mounting bumper next to a dock leveler, or where the space is too tight to allow the use of angles. Note: When using the flat plate, it is welded to the dock.

